



## HEALTH COMFORTABLE 002A/B

If accessories are not enough, Please contact with customer service.

Please confirm before assembly



Castors\*5



Base Legs\*1



Gaslift\*1



Headrest locks\*1

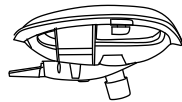

Seat\*1



Armrest\*2



Headrest\*1

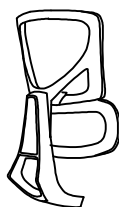

Chair back\*1



Allen wrench\*1



Screws for Seat and backrest \*4(C3)8\*27mm



Armrest screws \*6(C2)8\*27mm



X2 M6\*25Headrest screws

# Assembly method

01.

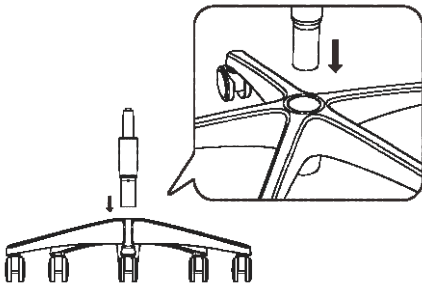

Please insert the lower part of the Gaslift(thicker part) into the base legs.

02.

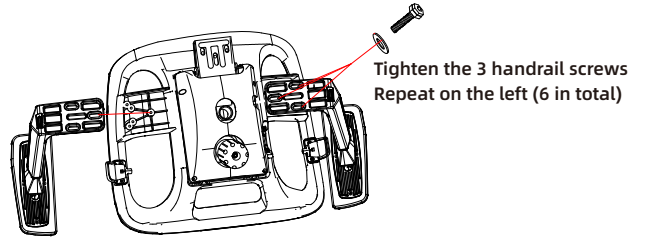

Align the left and right armrests with the screw holes on the seat surface, so that the lever extends outward, and tighten the screws from the underside of the seat cushion.

03.

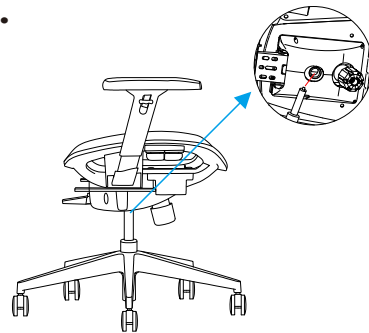

Insert the front of the Gaslift into the hole of the seat mechanism, Press from the seat and insert firmly.

04.

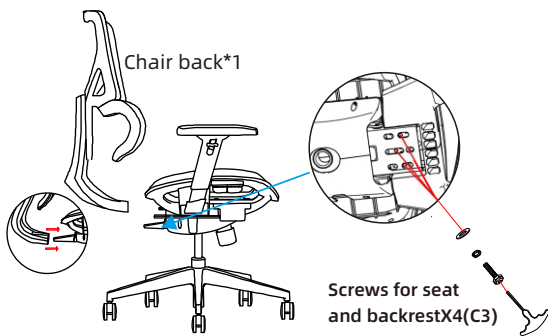

Please connect the seat with the lower part of the backrest, Fix it with screws.

05.



Insert the headrest into the middle hole of the backrest.

06.

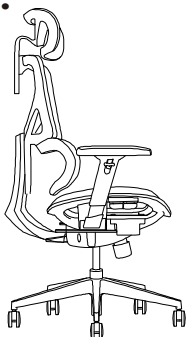

**Note:** Please check if there is any looseness or swing in each part before using the chair.